

50K

Mill Rotary Face Seals

High-Performance Face Seals for Bearing and Gearbox Protection

Chesterton® 50K face seals are high-performance face seals for heavy duty, dynamic rotary seal applications. These seals reduce the ingress of solid particles, dust and fluids, protecting housing and bearing areas. In severe applications, where exposure to external contaminants is extremely high, the 50K is used as secondary seal for additional protection in combination with other Chesterton rotary seals, which are in the primary seal position.





The unique design allows the 50K face seals to be used in a broad range of equipment across the heavy duty industries. High-performance elastomers create resistance to compression setting, wear, and aging. A broad range of engineered elastomers allow use in high and low temperature conditions and provide excellent fluid compatibility.

The 50K is manufactured by compression molding technology that provides accurate dimensional, geometrical tolerances, and improved fitting. According to industrial standards sizing, the 50K is a direct retrofit, which eliminates the need of equipment modification. The 50K is offered in different designs based on application requirements.



- Robust seal design stops contaminants from entering housing
- High-performance elastomers ensure plant-wide usage and long service life
- Optimized lip interference for low friction
- Direct retrofit eliminates equipment modification
- Mount and stretch directly on the shaft for easy assembly

AVAILABLE DESIGNS

Series	Usage
50KA 	with cross section profile that varies according to shaft diameter
50KAX 	with longer lip for heavy duty applications
50KL 	with narrow axial cross section fit to compact arrangements
50KE 	with special lip design for high performance sealing
50KRME 	with built-in housing for a radial retention metal clamp

Typical Applications

- Back-up rolls of hot and cold rolling mills
- Work rolls of hot and cold rolling mills
- Windmill applications
- Cement plants
- Power plants
- Rotary presses
- Calander lines

Seal Construction and Installation

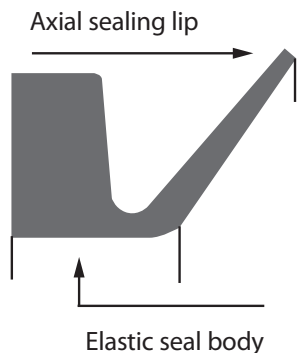

- The Face Seal is stretched on the shaft so there is interference between the shaft diameter and seal inner diameter creating radial sealing and clamping force.
- The axial deformation of the conical shaped lip creates axial sealing on the counter-face.
- The recommended lip preload values are indicated in the *Dimensional Items List* of the 50Ks.

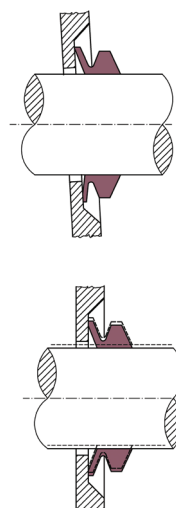
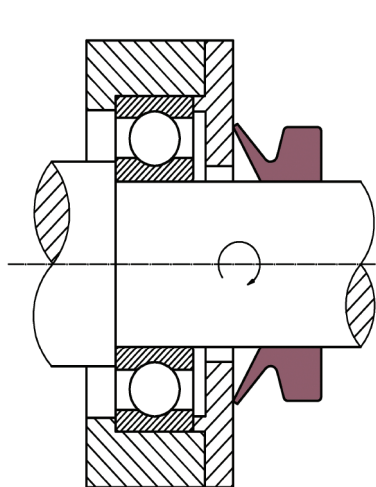

Improved lip design to compensate for shaft misalignments

Improved lip designed to compensate for shaft run-out

SPECIFICATIONS

Material	NBR70	FKM 70
Lubricating Greases	-20°C to 100°C (-4°F to 212°F)	-20°C to 150°C (-4°F to 302°F)
Water	5°C to 100°C (41°F to 212°F)	5°C to 80°C (41°F to 176°F)
Surface speed m/s (ft/min)	12 m/sec (2362 ft/min)*	20 m/sec* (3937 ft/min)
Technical pressure MPa (psi)	0.03 (4.35)	0.03 (4.35)
Size range mm (inch)** shaft dia	200 to 1650 (8 to 65)	200 to 1650 (8 to 65)

*At over 8 m/s (1574 ft/min) the seal has to be supported in axial direction while over 12 m/s radial (2362 ft/min) retention is needed.

** Please contact your Chesterton representative for other sizes.

RECOMMENDED SURFACE QUALITY

Hardness	Ra	Rmax
Min. 125 HB	0.4 - 0.8 µm (16 - 32 µin)	1-4 µm (39 - 157 µin)

Chesterton ISO certificates available on www.chesterton.com/corporate/iso

Technical data reflects results of laboratory tests and is intended to indicate general characteristics only. A.W. Chesterton Company disclaims all warranties express or implied, including warranties of merchantability and fitness for a particular purpose. Liability, if any, is limited to product replacement only. Any images contained herein are for general illustrative or aesthetic purposes only and are not intended to convey any instructional, safety, handling or usage information or advice respecting any product or equipment. Please refer to relevant Safety Data Sheets, Product Data Sheets, and/or Product Labels for safe use, storage, handling, and disposal of products, or consult with your local Chesterton sales representative.

© 2017 A.W. Chesterton Company.
 ® Registered trademark owned by A.W. Chesterton Company in USA and other countries, unless otherwise noted.

Distributed by: